



www.landgraff.no

Kapittel 5

TRINSER TUNG INDUSTRI

A.C. LANDGRAFF AS ble grunnlagt i Oslo 1947. Firmaet har fra starten spesialisert seg på hjul og trinser. Det ble produsert egne hjul i nært samarbeid med kunden, spesielt for slakterier og fiskeindustrien.

I dag importeres det meste som ferdigvare og halvfabrikat. Vi har et stort og rikholdig lager av hjul, gaffler, lager, dekk, slanger osv. som gjør at vi kan skreddersy de beste løsninger for spesielle ønsker og behov.

Vare sortimentet utvides stadig:

- Spesialhjul og deler for rullestoler m.m.
- Holker, plastinnsatser, stillskruer, låseratt m.m.
- Gassfjærer med diverse spesialtilpasninger.
- Traller vogner.
- Formstøpte PUR deler som armlener, leggputer m.m.

Vi representerer noen av de ledende produsenter på sine områder:



SVINGKRANSLAGER

Svingegenskapene til en trinse, påvirkes av forskjellige faktorer som utbygg, hjuldiameter og ikke minst konstruksjonen av svingkransen.

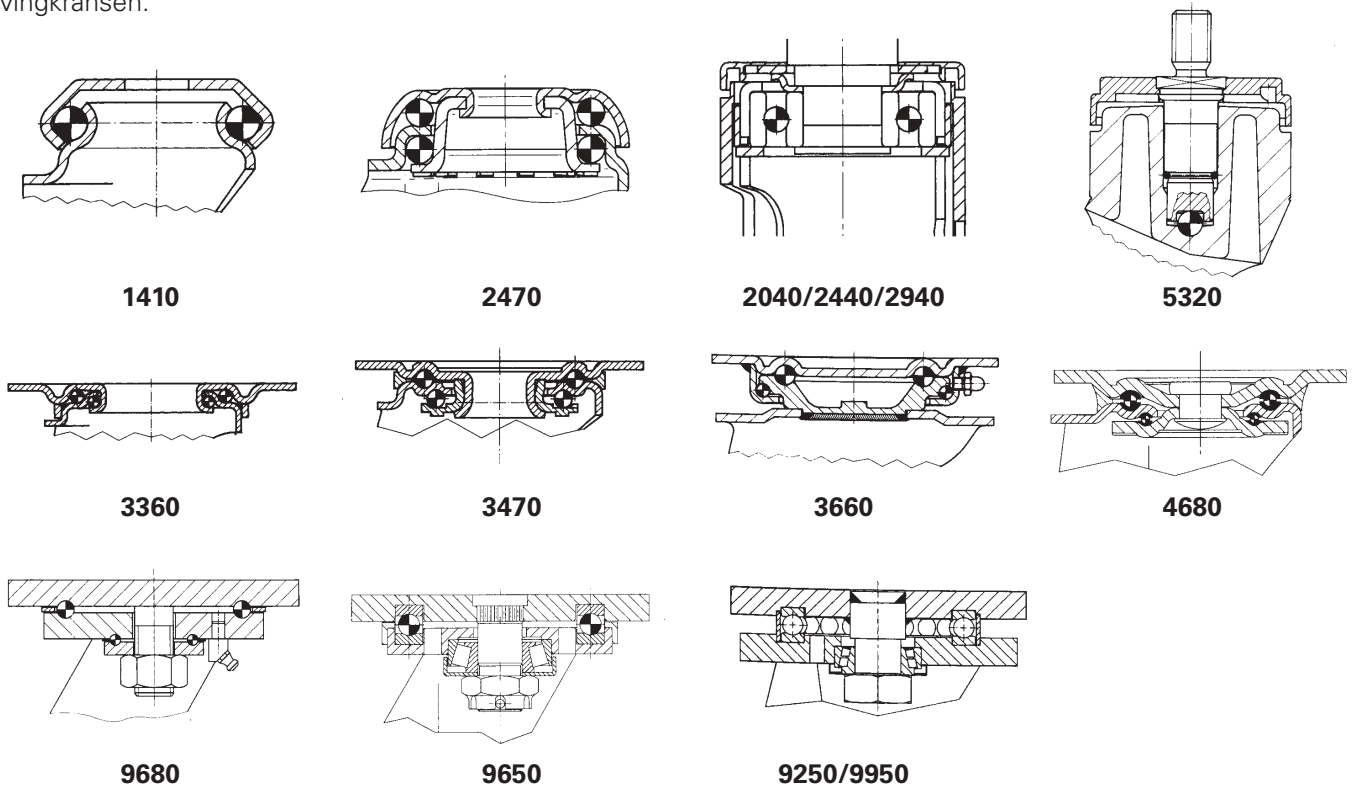

HJULLAGER

- KULELAGER:** Har lavest rullemotstand, høyest bæreevne og lang levetid selv ved kontinuerlig bruk.
RULLELAGER: Er robuste og anvendes i industrihjul hvor hastigheten ikke overstiger 5 km/t.
GLIDELAGER: Er nesten vedlikeholdsfrie og tåler støt+slag, egner seg best for vogner med korte rulleavstander.

BELASTNING: Grunnregelen for å velge riktig hjul/trinse:

$$\frac{\text{Vognens egenvekt} + \text{last}}{3}$$

3 hjul/trinse skal kunne bære totalvekten, et hjul kan være uten bakkekontakt hvis underlaget er ujevnt.

KONSTRUKSJONSBESKRIVELSER AV HJUL OG TRINSE

HJUL

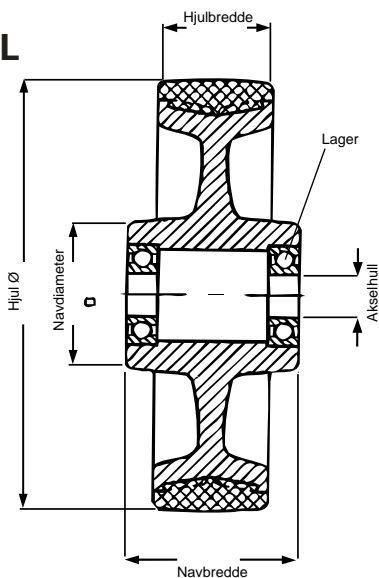

TRINSE

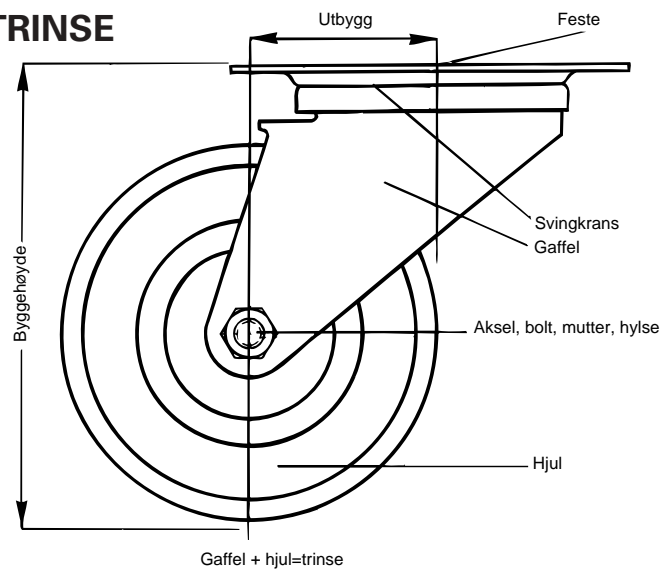

4680 - IEP ELASTISK GUMMI

- Gaffel og festeplate gulchromatisert kraftig presset stålplate
- Dobbelt kulelager i svingkrans med tetning
- Bremsen låser hjul og sving i en operasjon
- IEP elastisk gummi hjul på aluminiumsfelg m/kulelager



mm	mm	mm	mm	mm	mm	mm	kg (daN)	
125	50	164	51	140x110	105x80	11	300	4680 IEP 125 P63
160	50	200	53	140x110	105x80	11	350	4680 IEP 160 P63
200	50	240	53	140x110	105x80	11	400	4680 IEP 200 P63
250	50	292	54	140x110	105x80	11	450	4680 IEP 250 P63



mm	mm	mm	mm	mm	mm	mm	kg (daN)	
125	50	164		140x110	105x80	11	300	4688 IEP 125 P63
160	50	200		140x110	105x80	11	350	4688 IEP 160 P63
200	50	240		140x110	105x80	11	400	4688 IEP 200 P63
250	50	292		140x110	105x80	11	450	4688 IEP 250 P63



mm	mm	mm	mm	mm	mm	mm	kg (daN)	
125	50	164	51	140x110	105x80	11	300	4687 IEP 125 P63
160	50	200	53	140x110	105x80	11	350	4687 IEP 160 P63
200	50	240	53	140x110	105x80	11	400	4687 IEP 200 P63
250	50	292	54	140x110	105x80	11	450	4687 IEP 250 P63

4680 - ITP POLYURETAN

- Gaffel og festeplate gulchromatisert kraftig presset stålplate
- Dobbelt kulelager i svingkrans med tetning
- Bremsen låser hjul og sving i en operasjon
- ITP polyuretan bane på aluminiumsfelg m/kulelager



mm	mm	mm	mm	mm	mm	mm	kg (daN)	
125	50	164	51	140x110	105x80	11	500	4680 ITP 125 P63
160	50	200	53	140x110	105x80	11	800	4680 ITP 160 P63
200	50	240	53	140x110	105x80	11	800	4680 ITP 200 P63
250	50	292	54	140x110	105x80	11	800	4680 ITP 250 P63



mm	mm	mm	mm	mm	mm	mm	kg (daN)	
125	50	164		140x110	105x80	11	500	4688 ITP 125 P63
160	50	200		140x110	105x80	11	800	4688 ITP 160 P63
200	50	240		140x110	105x80	11	800	4688 ITP 200 P63
250	50	292		140x110	105x80	11	800	4688 ITP 250 P63



mm	mm	mm	mm	mm	mm	mm	kg (daN)	
125	50	164	51	140x110	105x80	11	500	4687 ITP 125 P63
160	50	200	53	140x110	105x80	11	800	4687 ITP 160 P63
200	50	240	53	140x110	105x80	11	800	4687 ITP 200 P63
250	50	292	54	140x110	105x80	11	800	4687 ITP 250 P63

ALTERNATIVE HJUL



UEP



UFP Grå



IFP Grå

ALTERNATIVER



Retningslås 4681 ITP











Retningslås 4681 IEP

4680 - TOP/TOO NYLONHJUL









- Dobbel kulebane i svingkrans
- Gaffel og festeplate av elforzinket stålplate

- **TOO** nylonhjul m/glidelager
- **TOP** nylonhjul m/kulelager











 mm	 mm	 mm	 mm	 mm	 mm	 mm	 kg (daN)	Svingbar trinse
TOP Nylon med kulelager								
125	50	164	51	140x110	105x80	11	700	4680 TOP 125 P63
150	50	195	53	140x110	105x80	11	800	4680 TOP 150 P63
160	50	200	53	140x110	105x80	11	800	4680 TOP 160 P63
200	50	240	53	140x110	105x80	11	800	4680 TOP 200 P63
250	50	292	54	140x110	105x80	11	800	4680 TOP 250 P63
TOO Nylon med glidelager								
125	50	164	51	140x110	105x80	11	700	4680 TOO 125 P63
150	50	195	53	140x110	105x80	11	800	4680 TOO 150 P63
160	50	200	53	140x110	105x80	11	800	4680 TOO 160 P63
200	50	240	53	140x110	105x80	11	800	4680 TOO 200 P63
250	50	292	54	140x110	105x80	11	800	4680 TOO 250 P63



 mm	 mm	 mm	 mm	 mm	 mm	 mm	 kg (daN)	Fast trinse
TOP Nylon med kulelager								
125	50	164		140x110	105x80	11	700	4688 TOP 125 P63
150	50	195		140x110	105x80	11	800	4688 TOP 150 P63
160	50	200		140x110	105x80	11	800	4688 TOP 160 P63
200	50	240		140x110	105x80	11	800	4688 TOP 200 P63
250	50	292		140x110	105x80	11	800	4688 TOP 250 P63
TOO Nylon med glidelager								
125	50	164		140x110	105x80	11	700	4688 TOO 125 P63
150	50	195		140x110	105x80	11	800	4688 TOO 150 P63
160	50	200		140x110	105x80	11	800	4688 TOO 160 P63
200	50	240		140x110	105x80	11	800	4688 TOO 200 P63
250	50	292		140x110	105x80	11	800	4688 TOO 250 P63



 mm	 mm	 mm	 mm	 mm	 mm	 mm	 kg (daN)	Svingbar trinse m/brems
TOP Nylon med kulelager								
125	50	164	51	140x110	105x80	11	700	4687 TOP 125 P63
150	50	195	53	140x110	105x80	11	800	4687 TOP 150 P63
160	50	200	53	140x110	105x80	11	800	4687 TOP 160 P63
200	50	240	53	140x110	105x80	11	800	4687 TOP 200 P63
250	50	292	54	140x110	105x80	11	800	4687 TOP 250 P63
TOO Nylon med glidelager								
125	50	164	51	140x110	105x80	11	700	4687 TOO 125 P63
150	50	195	53	140x110	105x80	11	800	4687 TOO 150 P63
160	50	200	53	140x110	105x80	11	800	4687 TOO 160 P63
200	50	240	53	140x110	105x80	11	800	4687 TOO 200 P63
250	50	292	54	140x110	105x80	11	800	4687 TOO 250 P63

ALTERNATIVER



Retningslås 4681



Stillas feste

9680/9250 - FTP

- Gaffel og festeplate, elforzinket sveiset stål
- Dobbelt herdet lager i svingkrans m/smørenippel og
- Bremsen låser hjul og sving i en operasjon
- FTP polyuretanbane på støpejernsfelg m/kulelager



9680



9250

mm	mm	mm	mm	mm	mm	mm	kg (daN)	Svingbar trinse
080	60	135	41	135x110	105x80	11	500	9680 ETP 080x60 P63
100	50	145	41	135x110	105x80	11	450	9680 FTP 100x50 P63
125	50	170	47	135x110	105x80	11	550	9680 FTP 125x50 P63
150	50	200	57	135x110	105x80	11	700	9680 FTP 150x50 P63
150	60	200	57	135x110	105x80	11	810	9680 FTP 150x60 P63
160	50	205	57	135x110	105x80	11	770	9680 FTP 160x50 P63
160	60	205	57	135x110	105x80	11	860	9680 FTP 160x60 P63
200	50	245	66	135x110	105x80	11	1000	9680 FTP 200x50 P63
200	60	245	66	135x110	105x80	11	1200	9680 FTP 200x60 P63
200	80	255	62	175x110	140x105	15	1400	9680 FTP 200x80 P64
250	50	305	70	135x110	105x80	11	1200	9680 FTP 250x50 P63
250	60	305	70	135x110	105x80	11	1200	9680 FTP 250x60 P63
250	80	305	74	175x140	140x105	15	1700	9680 FTP 250x80 P63
300	80	355	87	175x140	140x105	15	2000	9680 FTP 300x80 P64
9250								
250	100	325	78	200x160	160x120	15	2200	9250 FTP 250 P65
300	100	370	88	200x160	160x120	15	2600	9250 FTP 300 P65
300	100	370	88	250x200	210x160	17	2600	9250 FTP 300 P66
400	100	470	115	250x200	210x160	17	3200	9250 FTP 400 P66



9688



9258

mm	mm	mm	mm	mm	mm	mm	kg (daN)	Fast trinse
080	60	135		135x110	105x80	11	500	9688 ETP 080x60 P63
100	50	145		135x110	105x80	11	450	9688 FTP 100x50 P63
125	50	170		135x110	105x80	11	550	9688 FTP 125x50 P63
150	50	200		135x110	105x80	11	700	9688 FTP 150x50 P63*
150	60	200		135x110	105x80	11	810	9688 FTP 150x60 P63*
160	50	205		135x110	105x80	11	770	9688 FTP 160x50 P63*
160	60	205		135x110	105x80	11	860	9688 FTP 160x60 P63*
200	50	245		135x110	105x80	11	1000	9688 FTP 200x50 P63*
200	60	245		135x110	105x80	11	1200	9688 FTP 200x60 P63*
200	80	255		175x110	140x105	15	1400	9688 FTP 200x80 P64*
250	50	305		135x110	105x80	11	1200	9688 FTP 250x50 P63*
250	60	305		135x110	105x80	11	1200	9688 FTP 250x60 P63*
250	80	305		175x140	140x105	15	1700	9688 FTP 250x80 P64*
300	80	355		175x140	140x105	15	2000	9688 FTP 300x80 P64*
9258								
250	100	325		200x160	160x120	15	2200	9258 FTP 250 P65
300	100	370		200x160	160x120	15	2600	9258 FTP 300 P65
300	100	370		250x200	210x160	17	2600	9258 FTP 300 P66
400	100	470		250x200	210x160	17	3200	9258 FTP 400 P66



9682

mm	mm	mm	mm	mm	mm	mm	kg (daN)	Svingbar trinse m/brems
125	50	170	47	135x110	105x80	11	550	9682 FTP 125x50 P63
150	50	200	57	135x110	105x80	11	700	9682 FTP 150x50 P63*
150	60	200	57	135x110	105x80	11	810	9682 FTP 150x60 P63*
160	50	205	57	135x110	105x80	11	770	9682 FTP 160x50 P63*
160	60	205	57	135x110	105x80	11	860	9682 FTP 160x60 P63*
200	50	245	66	135x110	105x80	11	1000	9682 FTP 200x50 P63*
200	60	245	66	135x110	105x80	11	1200	9682 FTP 200x60 P63*
200	80	255	62	175x110	140x105	15	1400	9682 FTP 200x80 P64*
250	50	305	70	135x110	105x80	11	1200	9682 FTP 250x50 P63*
250	60	305	70	135x110	105x80	11	1200	9682 FTP 250x60 P63*
250	80	305	74	175x140	140x105	15	1700	9682 FTP 250x80 P64*
300	80	355	87	175x140	140x105	15	2000	9682 FTP 300x80 P64*

ALTERNATIVE HJUL



ITP



FOR/FOP



Med fjæring

ALTERNATIVER











* Retningslås 9681









9680 - IEP/FVP

- Gaffel og festeplate, elforzinket sveiset stål
- Dobbelt herdet lager i svingkrans m/smørenippel
- Bremsen låser hjul og sving i en operasjon
- **IEP** elastisk gummi på aluminiumsfelg
- **FVP** elastisk gummi på støpejernsfelg











 mm	 mm	 mm	 mm	 mm	 mm	 mm	 kg (daN)	Svingbar trinse
Svingbar IEP								
125	50	170	47	135x110	105x80	11	300	9680 IEP 125 P63
160	50	205	57	135x110	105x80	11	350	9680 IEP 160 P63
200	50	245	66	135x110	105x80	11	400	9680 IEP 200 P63
250	50	305	70	135x110	105x80	11	500	9680 IEP 250 P63











 mm	 mm	 mm	 mm	 mm	 mm	 mm	 kg (daN)	Svingbar FVP
Svingbar FVP								
200	75	255	60	175x140	140x105	15	500	9680 FVP 200 P64
250	80	305	65	175x140	140x105	15	675	9680 FVP 250 P64
300	85	355	70	175x140	140x105	15	800	9680 FVP 300 P64











 mm	 mm	 mm	 mm	 mm	 mm	 mm	 kg (daN)	Fast trinse
Fast trinse IEP								
125	50	170		135x110	105x80	11	300	9688 IEP 125 P63
160	50	205		135x110	105x80	11	350	9688 IEP 160 P63
200	50	245		135x110	105x80	11	400	9688 IEP 200 P63
250	50	305		135x110	105x80	11	500	9688 IEP 250 P63











 mm	 mm	 mm	 mm	 mm	 mm	 mm	 kg (daN)	Fast trinse FVP
Fast trinse FVP								
200	75	255		175x140	140x105	15	500	9688 FVP 200 P64
250	80	305		175x140	140x105	15	675	9688 FVP 250 P64
300	85	355		175x140	140x105	15	800	9688 FVP 300 P64



 mm	 mm	 mm	 mm	 mm	 mm	 mm	 kg (daN)	Svingbar trinse m/brems
Svingbar m/brems IEP								
125	50	170	47	135x110	105x80	11	300	9682 IEP 125 P63
160	50	205	57	135x110	105x80	11	350	9682 IEP 160 P63
200	50	245	66	135x110	105x80	11	400	9682 IEP 200 P63
250	50	305	70	135x110	105x80	11	500	9682 IEP 250 P63



 mm	 mm	 mm	 mm	 mm	 mm	 mm	 kg (daN)	Svingbar m/brems FVP
Svingbar m/brems FVP								
200	75	255	60	175x140	140x105	15	500	9682 FVP 200 P64
250	80	305	65	175x140	140x105	15	675	9682 FVP 250 P64
300	85	355	70	175x140	140x105	15	800	9682 FVP 300 P64

ALTERNATIVER



Retningslås 9681 IEP











Retningslås 9681 FVP

9680 - TOP/TOO NYLON









- Gaffel og festeplate av elforzinket sveiset stål
- Dobbel kulekrans m/tetning (herdet kulebane)

- Smørenipper i svingkrans
- **TOP** nylon m/kulelager **TOO** nylon m/glidelager











 mm	 mm	 mm	 mm	 mm	 mm	 mm	 kg (daN)	Svingbar trinse
TOP Kulelager								
100	50	145	41	135x110	105x80	11	600	9680 TOP 100 P63
125	50	170	47	135x110	105x80	11	700	9680 TOP 125 P63
150	50	200	57	135x110	105x80	11	800	9680 TOP 150 P63
160	50	205	57	135x110	105x80	11	850	9680 TOP 160 P63
200	50	245	66	135x110	105x80	11	1000	9680 TOP 200 P63
250	50	305	70	135x110	105x80	11	1100	9680 TOP 250 P63
TOO Glidelager								
100	50	145	41	135x110	105x80	11	600	9680 TOO 100 P63
125	50	170	47	135x110	105x80	11	700	9680 TOO 125 P63
150	50	200	57	135x110	105x80	11	800	9680 TOO 150 P63
160	50	205	57	135x110	105x80	11	850	9680 TOO 160 P63
200	50	245	66	135x110	105x80	11	1000	9680 TOO 200 P63
250	50	305	70	135x110	105x80	11	1100	9680 TOO 250 P63



 mm	 mm	 mm	 mm	 mm	 mm	 mm	 kg (daN)	Fast trinse
TOP Kulelager								
100	50	145		135x110	105x80	11	600	9688 TOP 100 P63
125	50	170		135x110	105x80	11	700	9688 TOP 125 P63
150	50	200		135x110	105x80	11	800	9688 TOP 150 P63
160	50	205		135x110	105x80	11	850	9688 TOP 160 P63
200	50	245		135x110	105x80	11	1000	9688 TOP 200 P63
250	50	305		135x110	105x80	11	1100	9688 TOP 250 P63
TOO Glidelager								
100	50	145		135x110	105x80	11	600	9688 TOO 100 P63
125	50	170		135x110	105x80	11	700	9688 TOO 125 P63
150	50	200		135x110	105x80	11	800	9688 TOO 150 P63
160	50	205		135x110	105x80	11	850	9688 TOO 160 P63
200	50	245		135x110	105x80	11	1000	9688 TOO 200 P63
250	50	305		135x110	105x80	11	1100	9688 TOO 250 P63



 mm	 mm	 mm	 mm	 mm	 mm	 mm	 kg (daN)	Svingbar trinse m/brems
TOP Kulelager								
100	50	145	41	135x110	105x80	11	600	9682 TOP 100 P63
125	50	170	47	135x110	105x80	11	700	9682 TOP 125 P63
150	50	200	57	135x110	105x80	11	800	9682 TOP 150 P63
160	50	205	57	135x110	105x80	11	850	9682 TOP 160 P63
200	50	245	66	135x110	105x80	11	1000	9682 TOP 200 P63
250	50	305	70	135x110	105x80	11	1100	9682 TOP 250 P63
TOO Glidelager								
100	50	145	41	135x110	105x80	11	600	9682 TOO 100 P63
125	50	170	47	135x110	105x80	11	700	9682 TOO 125 P63
150	50	200	57	135x110	105x80	11	800	9682 TOO 150 P63
160	50	205	57	135x110	105x80	11	850	9682 TOO 160 P63
200	50	245	66	135x110	105x80	11	1000	9682 TOO 200 P63
250	50	305	70	135x110	105x80	11	1100	9682 TOO 250 P63

ALTERNATIVER



Retningslås 9681



MOP

9950 - TVILLINGTRINSE FTP POLYURETAN

- Herdet kulebane+konisk rullelager i svingkrans m/smørenippel
- **STP** polyuretanbane på sveiset stålfelg m/kulelager
- **FTP** polyuretanbane på støpejernsfelg m/kulelager



mm	mm	mm	mm	mm	mm	mm	kg (daN)	Svingbar trinse
100	2x50	180	40	200x160	160x120	15	900	9950 FTP 100 P65
125	2x50	205	48	200x160	160x120	15	1000	9950 FTP 125 P65
150	2x50	230	53	200x160	160x120	15	1400	9950 FTP 150 P65
160	2x50	235	53	200x160	160x120	15	1500	9950 FTP 160 P65
200	2x50	275	64	200x160	160x120	15	2000	9950 FTP 200 P65
200	2x80	315	62	270x250	230x210	17	2800	9950 FTP 200 P70
250	2x50	325	78	200x160	160x120	15	2200	9950 FTP 250 P65
250	2x80	365	74	270x250	230x210	17	3600	9950 FTP 250 P70
300	2x80	514	85	270x250	230x210	17	4000	9950 FTP 300 P70
360	2x80	490	97	270x250	230x210	17	4800	9950 FTP 360 P70
400	2x80	510	106	270x250	230x210	17	5000	9950 FTP 400 P70
500	2x80	610	129	270x250	230x210	17	6000	9950 STP 500 P70



mm	mm	mm	mm	mm	mm	mm	kg (daN)	Fast trinse
100	2x50	180		200x160	160x120	15	900	9958 FTP 100 P65
125	2x50	205		200x160	160x120	15	1000	9958 FTP 125 P65
150	2x50	230		200x160	160x120	15	1400	9958 FTP 150 P65
160	2x50	235		200x160	160x120	15	1500	9958 FTP 160 P65
200	2x50	275		200x160	160x120	15	2000	9958 FTP 200 P65
200	2x80	315		270x250	230x210	17	2800	9958 FTP 200 P70
250	2x50	325		200x160	160x120	15	2200	9958 FTP 250 P65
250	2x80	365		270x250	230x210	17	3600	9958 FTP 250 P70
300	2x80	514		270x250	230x210	17	4000	9958 FTP 300 P70
360	2x80	490		270x250	230x210	17	4800	9958 FTP 360 P70
400	2x80	510		270x250	230x210	17	5000	9958 FTP 400 P70
500	2x80	610		270x250	230x210	17	6000	9958 STP 500 P70

9950 - TVILLINGTRINSE/TOP NYLON

- Herdet kulebane+konisk rullelager i svingkrans m/smørenippel
- **TOP** nylonhjul m/kulelager



mm	mm	mm	mm	mm	mm	mm	kg (daN)	Svingbar trinse
100	2x50	180	40	200x160	160x120	15	1200	9950 TOP 100 P65
125	2x50	205	48	200x160	160x120	15	1400	9950 TOP 125 P65
150	2x50	230	53	200x160	160x120	15	1600	9950 TOP 150 P65
160	2x50	235	53	200x160	160x120	15	1700	9950 TOP 160 P65
200	2x50	275	64	200x160	160x120	15	2000	9950 TOP 200 P65
250	2x50	325	78	270x160	230x120	17	2200	9950 TOP 250 P70



mm	mm	mm	mm	mm	mm	mm	kg (daN)	Fast trinse
100	2x50	180		200x160	160x120	15	1200	9958 TOP 100 P65
125	2x50	205		200x160	160x120	15	1400	9958 TOP 125 P65
150	2x50	230		200x160	160x120	15	1600	9958 TOP 150 P65
160	2x50	235		200x160	160x120	15	1700	9958 TOP 160 P65
200	2x50	275		200x160	160x120	15	2000	9958 TOP 200 P65
250	2x50	325		270x160	230x120	17	2200	9958 TOP 250 P70

ALTERNATIVER



Spesial 11 tonn



Retningslås



MOP

1. Leveringsbetingelser

Rettsforholdet mellom kjøper og A.C.LANDGRAFF AS (ACL) bedømmes etter norsk lov med nedenforstående endringer.

2. Tilbud og priser

Muntlige tilbud skal aksepteres straks, ellers er de å regne som bortfalt. Skriftlige tilbud er gjeldende i 28 dager etter tilbudsdato såfremt annet ikke er notert, deretter er tilbudet bortfalt. Prisen er forbeholdt for lønns- og materialpris-stigning samt svingninger i valutakursene.

3. Levering

Levering skjer med mindre annet er avtalt fritt vårt lager. Spesialproduserte varer, herunder spesialfarver kan over/under leveres med 10%

Ordre under det til enhver tid gjeldende minimum kjøp tillegges det til enhver tid gjeldende småordretillegg. Pr. i dag tillegges ordre under kr. 300,- et tillegg på kr. 40,-.

Retur av varer kan kun skje etter avtale og skal da sendes fritt vårt lager. Ved retur beregnes et returgebyr på 10% dog minimum kr. 150,-.

4. Mangler og ansvar

Reklamasjoner over antallsmangler skal skje straks etter mottagelsen av varene ellers bortfaller reklamasjonsretten. Reklamasjoner over øvrige mangler skal skje innen 8 dager fra mottagelsen ellers bortfaller reklamasjonsretten. Vårt ansvar er begrenset til ny levering med reklamasjonsfri vare eller maksimert til faktura-beløpet, etter vårt valg.

5. Force majeure

Følgende utvidede force majeure fritar ACL for forsinkelsesansvar: Krig, brann, streik, lockout, vær, ut-og innførselsforbud, beslagleggelser eller forsinkelser fra underleverandører eller andre omstendigheter som ACL ikke forutså eller burde ha forutsett.

6. Produktansvar

Selgeren er ikke ansvarlig for skade på produkter som er fremstilt av kjøperen. Selgeren er ikke ansvarlig for driftstap, tapt arbeidsfortjeneste eller annet indirekte tap.

7. Generelt

Alle mål, farveangivelser, belastningsoppgaver m.m. kan endres uten forvarsel.

8. Kvalitetssikring

De fleste av våre leverandører er ISO 9001-sertifisert.

A.C. Landgraff AS

P. boks 14, N-1305 Haslum
Nesveien 13, N-1344 Haslum
Tlf.: (+47) 67 52 60 00
Faks: (+47) 67 53 88 12
e-post: landgraff@landgraff.no
www.landgraff.no